

Varenummer: 0102123
 Beskrivelse: Seeger låsering J 150 DIN 472
 Fjederstål

Mål

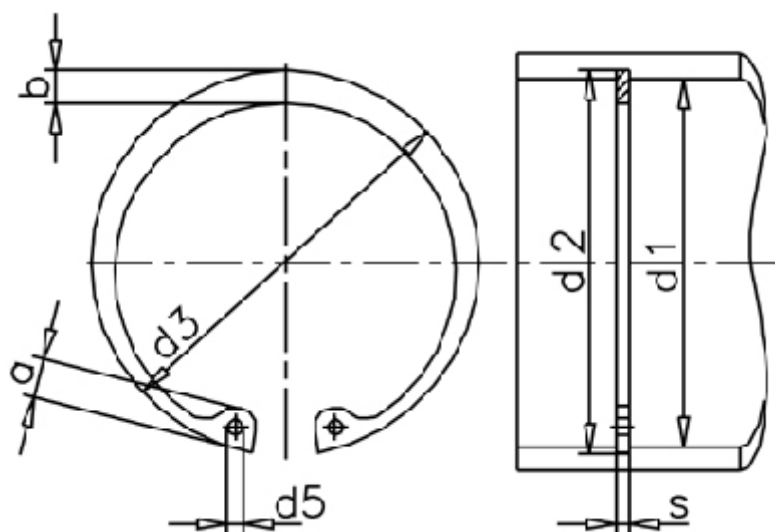

a max	= 12,0	FN kN	= 191.00	t	= 2.00
AN mm ²	= 1198.0	FRg kN	= 64.0	Tang	= ZGJ-4
b	= 11.2	FR kN	= 326.0	tol	= -0.10
Betegnelse	= J 150	g	= 3.0	tol	= +1,50-0,63
d1	= 150	K kN-mm	= 748.0	tol	= +0,63
d2	= 155.0	m min	= 4.15	vægt kg/1000	= 105.00
d3	= 158.00	Nominel træk	= 6.0		
d5 min	= 4.0	s	= 4.00		